

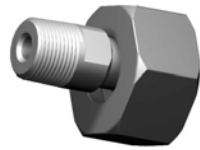

Easy Fit Up Union
O-ring size 2-116 Viton
(nut omitted for clarity)



Floating Tailpiece
± 1/4" adjustment on C-C



COMBO: T100 / T200 Series
Transparent Liquid Level Gage
with FT15 "Free Turn"
Single Union Offset Pattern Gage Valve
Drawing Rev: A
Drawing Date: 08/10/15
Revision Date: 02/20/19

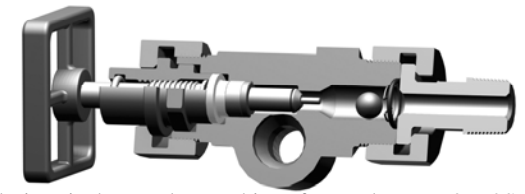

"Free Turn" design- isolates valve workings from salt water & H2S
Prevents internal corrosion that causes conventional valves to seize
Patent No. 6,991,216

www.infernomfg.com/PDF/FILL.swf

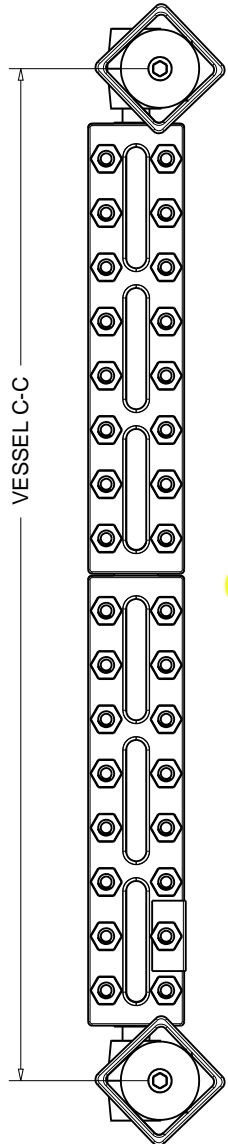

Vessel Connection Behind Gage Face
Fig. 4-1

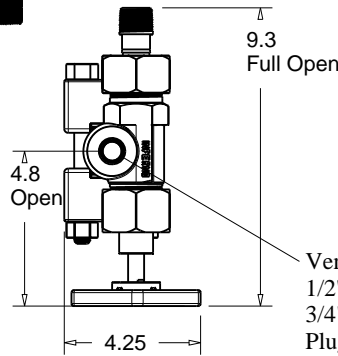
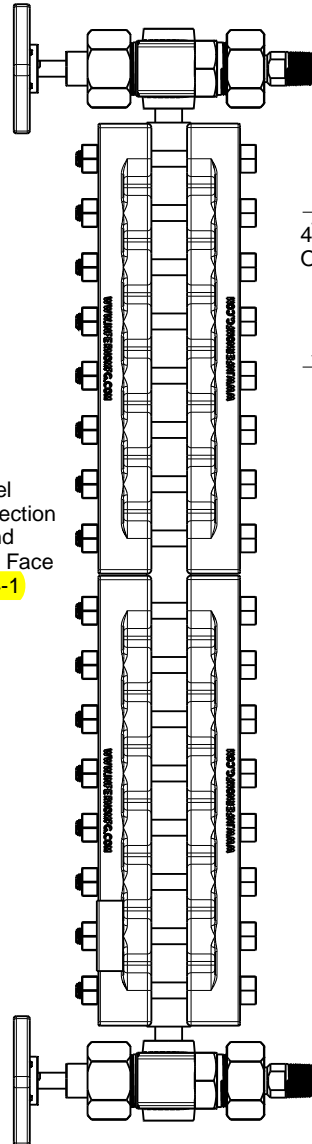

Vent / Drain port
1/2" F-NPT std
3/4" F-NPT optional
Plug or Ball Valve Optional

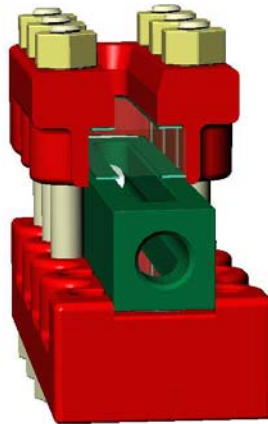

All steel construction
Wetted per NACE
Tempered borosilicate glass
Flexible graphite seal w SS insert
Standard finish -
Zinc plated body and bolting
Powder coat cover
Epoxy paint valve

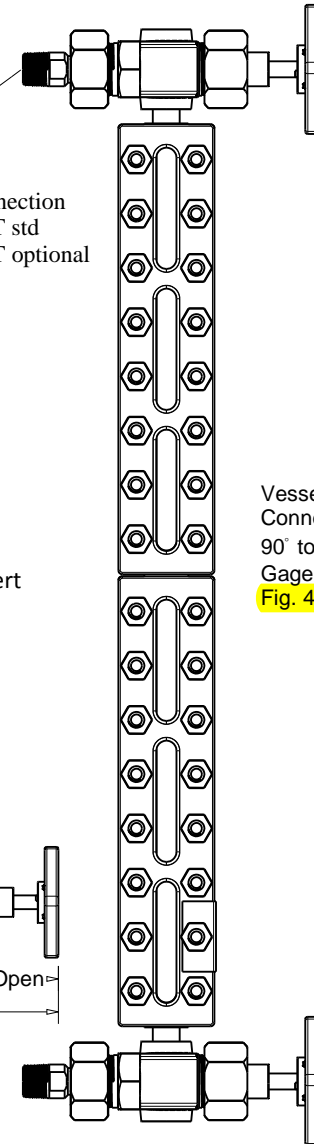
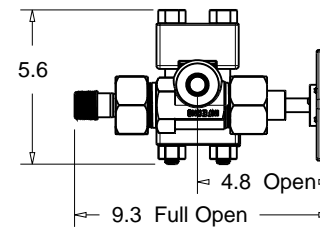

Vessel Connection 90° to Gage Face
Fig. 4-2

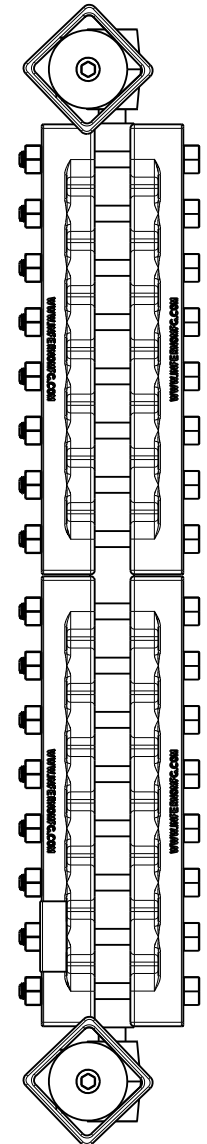

© 2015 Inferno Mfg. Corp. all rights reserved
www.infernomfg.com

This drawing is the property of Inferno Mfg. Corp.
and may not be reproduced without permission